

Solo Sensing Edges for As-Interface

Information Sheet



Features

- Custom configurations
- Wide range of models
- Choice of colours
- Optional sensitivities
- Variety of mounting options
- TÜV approved
- Easy installation
- Fail-safe wiring available
- Durable construction
- Customised profiles to suit customer specification
- Volt-free, normally closed contacts

Tapeswitch sensing edges are press-at-any-point, momentary, normally-open contacts designed to protect personnel and equipment. They are typically mounted on the leading edge of a moving object, such as a powered door, such that the sensor is activated when it meets an obstruction. The major difference between a *Solo* sensing edge and any other standard edge is that it has a Category 3 fail-safe monitoring function built into it. A pair of redundant contacts are closed when the edge is not activated and open when it is pressed. This configuration is for use with AS-Interface systems, which connect sensors and actuators to remote control-systems through only a 2-wire cable. The edges can be connected directly to the same kind of standard AS-Interface Safe I/O connection modules that are used to connect E-stop switches over the AS-Interface. This is much more convenient than the alternative of having an additional control unit close to the edge so that it can provide the volt-free, normally closed connections to the AS-Interface Safe I/O module.

Due to the versatility of our product we can also provide customised profiles to meet the customer's specification.

The solo option is available on any of the Tapeswitch range of sensing edges.

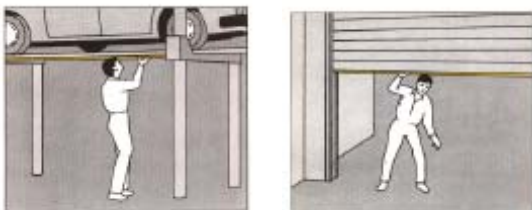

Typical Applications:

- Automated factory environments
- Car Plants
- Conveyors
- Scissor Lifts
- Access control

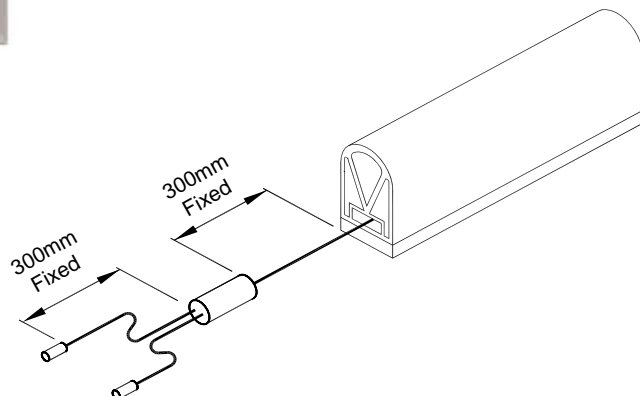

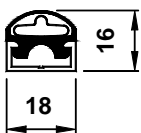

TS6

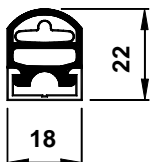

TS16

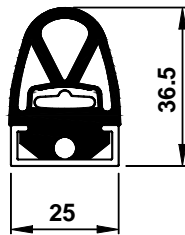

KS3003

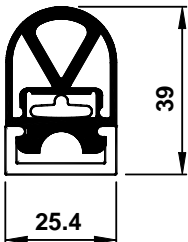
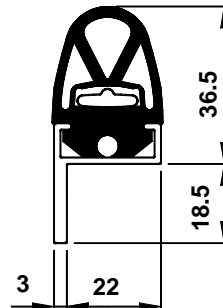

TS26C

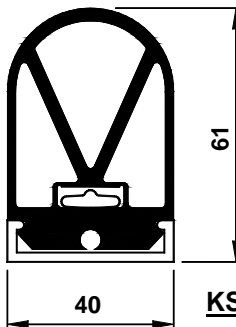
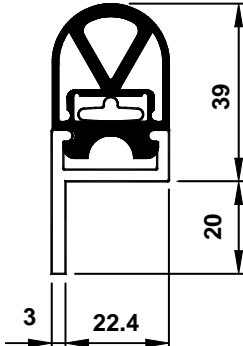

KS1001

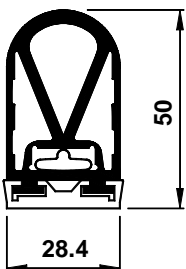

TS46D

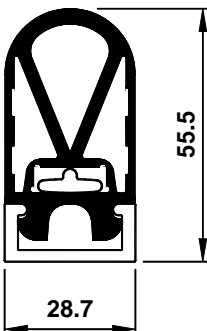
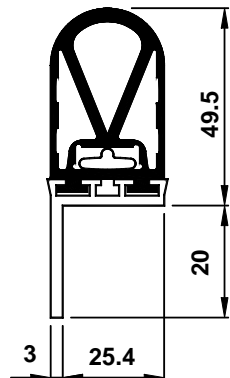

TS48

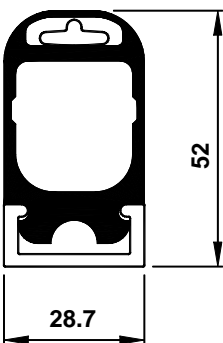
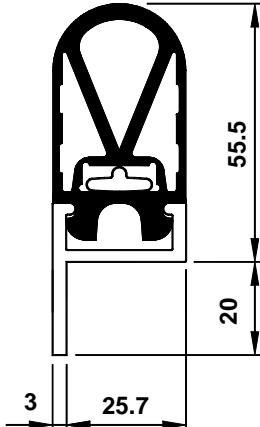

TS47

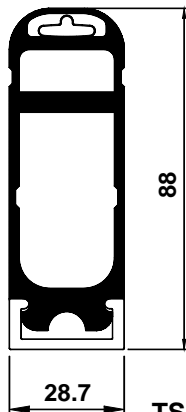
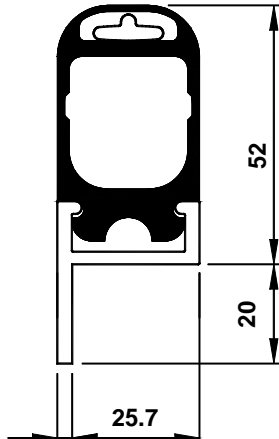

TS57

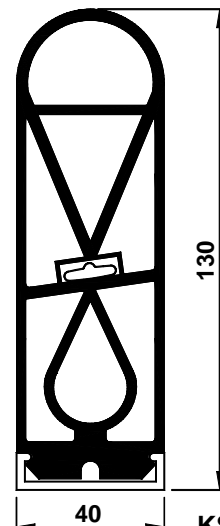

KS4401

Mounting Options

All Tapeswitch edge profiles have an aluminium channel in either flat or angled, some of the smaller profiles have a plastic option. For full details please see our separate sensing edge information sheet.

Holes can be drilled in the channel to suit most requirements, please call our sales team for more information.

Accessories

End-caps and end-covers are available dependent upon the profile, please call our sales team for details.

Order Code: **XXXXSolo / XXXX / X / X / X / SLZ / OE / 300M12 / 8V2 / X**

Sensor Type	_____
Sensor Overall Length (mm)	_____
Channel Style	_____
F - Flat A - Angle	
Channel Material	_____
A - Aluminium P - Plastic	
Housing Colour	_____
B - Black R - Red Y - Yellow	
Lead Type	_____
SLZ	
Lead Exit	_____
OE	
Lead Length 1	_____
M12 connectors 300mm—optional lengths available as a special	
8V2	_____
End Caps	_____
Y/N	